



Electrochemical Signal Analyzer

Electrochemical noise, the current and voltage signals arising from freely corroding electrochemical systems, has been studied for over 20 years. Despite this experience, it often suffers from invalid data acquisition and inconsistent analysis.

The Electrochemical Signal Analyzer is. Its primary goal is to assist in the evaluation of noise as a technique for the routine study of chemical processes by providing a convenient package for versatile data acquisition and sophisticated data analysis.

For acquisition, the software partners with any Gamry potentiostat to generate reliable data in either potentiostatic, galvanostatic, or zero resistance ammeter (ZRA) mode. Careful attention is paid to sample continuity, acquisition rate, filtering, and autoranging to provide the most accurate signal representation.

This software is a generational improvement over the ESA400. It provides a more straightforward user interface, optimized current & voltage autoranging, higher speed sampling with better alias rejection, and more useful overrange information. An adjustable offset window algorithm keeps the instrument performing at the optimum resolution. The Electrochemical Signal Analyser Software now incorporates a separate logging function so long-term tests need not be interrupted to annotate or modify the experiment.

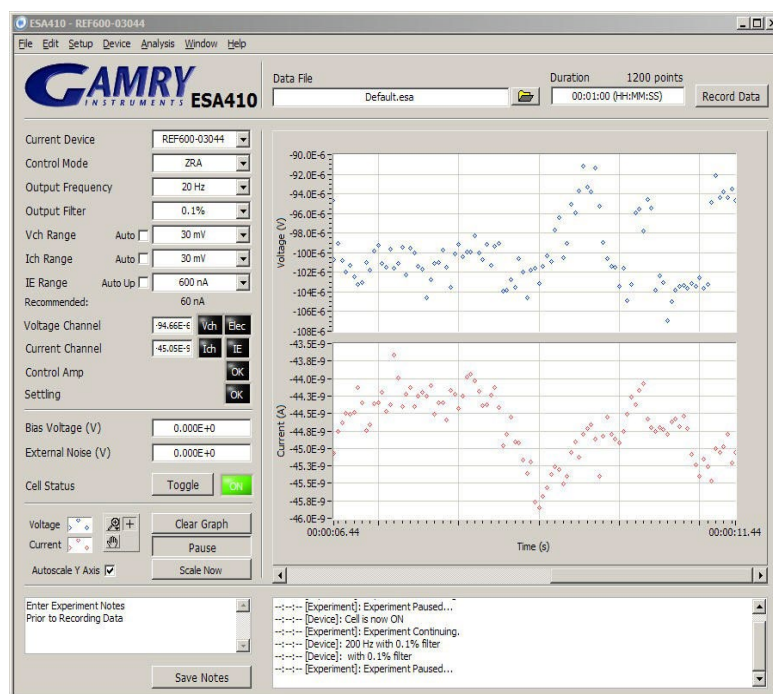

To transform the noise into information, the software provides an impressive package of signal analysis tools: blockwise statistics, Fourier and MEM frequency domain analysis, correlation analysis, histograms, and the powerful JFTA (Joint Time- Frequency Analysis). These algorithms can be used to calculate quantitative results from the data. When there is information buried in electrochemical noise, the software gives you the power to find it.

Features

- Acquisition in potentiostat, galvanostatic, zero resistance ammeter, or biased zero resistance ammeter modes
- Wide range of data acquisition frequencies
- Unlimited data acquisition length
- Full complement of signal processing techniques
- Real-time display of mean, RMS, sigma, variance, skewness, kurtosis, instantaneous resistance (E/I), and FFT
- Matched linear phase anti-aliasing filters
- Flexible real-time charting with zoom and pan
- Adjustable length buffer for post acquisition analysis
- Up to 4 simultaneous acquisitions
- Complete import and export capability
- Current and voltage autoranging
- Synthesized white noise for spectral analysis

Electrochemical Noise Overview

Various physical and chemical processes can give rise to seemingly random low-frequency signals. These phenomena include pitting and crevice corrosion, uniform corrosion, coating failure, inhibitor activity, cracking, passive film stability, adsorption, and gas generation. The potential and/or current fluctuations from these stochastic processes, taken as a group, are referred to as electrochemical noise.

Noise signals may be acquired in several ways. Performing the experiment with two identical electrodes under open-circuit conditions with a Zero Resistance Ammeter/Electrometer allows a measurement to be made with no external perturbation, closely simulating ambient real-world conditions. Both potential and current can be measured simultaneously.

The Electrochemical Signal Analyzer Software can also be used in our unique Biased ZRA mode. Imposing a potential between two identical electrodes tends to move the anodic corrosion processes to the positively polarized electrode. This insures that more of the relevant current is measured. It also provides a useful way to electrochemically stress a material to measure its resistance to localized corrosion.

Some researchers find it advantageous to study the system under either potentiostatic or galvanostatic control to accelerate a particular process such as passivation. In this case, the current and potential, respectively, are monitored versus time. The software allows both potentiostatic and galvanostatic control in addition to ZRA mode.

Three Electrode Biased ZRA/Electrometer

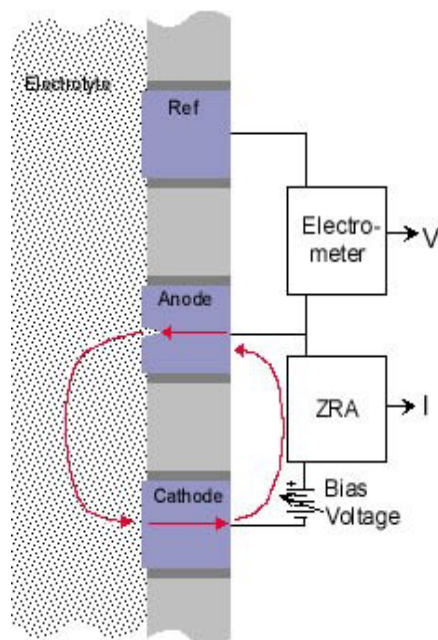

The Electrochemical Signal Analyzer can also apply a computer-generated white noise signal to the system under test. While this may seem an anomaly for an electrochemical noise instrument, it is useful for improving the performance of the instrument when used for impedance analysis.

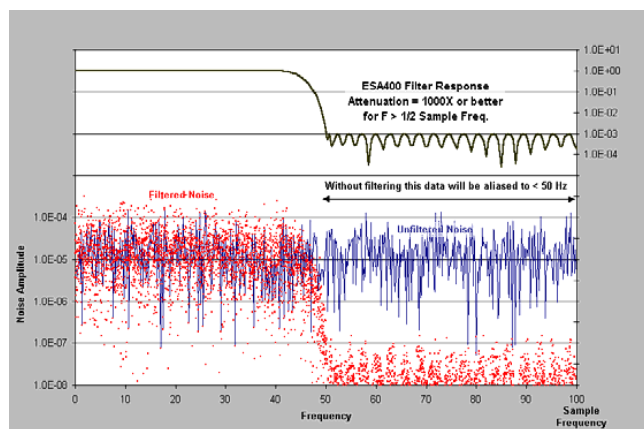

White Noise Sampled at 100 Hz
Filtered (Red Dots) vs Unfiltered (Blue)

In all cases, it is extremely important to differentiate the signals generated by the chemical process from the electronic noise of the instrument. We pay special attention to maintaining data integrity by using filters tuned to the sampling rate according to the Nyquist anti-aliasing criterion, which states that signals at frequencies greater than $\frac{1}{2}$ the sampling frequency will appear as lower frequencies. High frequency computer noise is effectively eliminated in the software by a series of analog and digital filters. The filters are designed to be linear in phase, insuring that peak shapes and higher order statistical moments are not distorted.

The Right Hardware for Signal Analysis

Electrochemical noise signals are often very small. The Electrochemical Signal Analyzer utilizes the offset and gain capability of your Gamry Potentiostat family to achieve 1 μ V and 100 fA resolution to observe even the most subtle interactions. Think of this as using a magnifying glass to zoom in on a relatively stationary portion of your signal. A unique DC offset circuit subtracts out the background level so you can subsequently apply a final amplification of x1, x10 or x100. Offset and gain are calculated and adjusted continuously in the background during the data acquisition.

To eliminate switching transients, a single potentiostat is dedicated to gathering data for one sample. To increase the productivity of your laboratory, the software can control up to eight potentiostats *simultaneously*, each running an independent noise experiment with different potentiostat ranges and settings.

The time scale of an electrochemical noise measurement is difficult to predict. Accordingly, the Electrochemical Signal Analyzer has been designed to monitor potential and current signals *continuously* in an uninterrupted fashion. If you wish, you can collect data for months! This way, you won't miss any long-term events that may require an initiation period. You are literally limited only by the free space on your hard drive! To conserve space on your hard drive, we save the data as a binary file of voltage and current records.

The data can be collected at a selectable sampling rate from 1000 Hz to 0.1 Hz. The choice of data acquisition rate is dependent on the time scale of the phenomena being studied. Electrochemical Impedance Spectroscopy performed using the Gamry EIS Software is an excellent method to identify an appropriate sampling frequency.

Tools for Signal Analysis

Researchers are still studying signal analysis techniques to determine which are the most useful. To help you decide, we've supplied the software with a versatile, inclusive collection of mathematical tools for signal analysis.

Data from noise experiments is acquired in the time domain, i.e., current and/or potential is measured versus

time. For analysis, it is often convenient to convert this data into the frequency domain in which a function of the signal amplitude is plotted versus frequency. This spectral representation can be accomplished with the Fast Fourier Transform (FFT) or the Maximum Entropy Method (MEM) approximation.

Real-Time Statistics

To help you recognize when a significant event has occurred, the software continuously calculates several statistics on the I and V data streams. In addition a real-time FFT can be calculated. The statistical functions are calculated on user-specified blocks of raw data ranging

from 32 to 16,384 data points per block. Up to four of the following calculations can be displayed in real time, one per screen quadrant.

The same statistics may also be calculated on previously acquired data stored in files.

V & I vs. Time: $x[i]$ vs $t[i]$

$$\text{Block Average: } \bar{x} = \frac{1}{N} \sum_{i=0}^{N-1} x[i]$$

$$\text{RMS: } x_{rms} = \sqrt{\frac{1}{N} \sum_{i=0}^{N-1} x[i]^2}$$

$$\text{Standard Deviation*} : x_{\sigma} = \sqrt{\frac{1}{N} \sum_{i=0}^{N-1} (x[i] - \bar{x})^2}$$

$$\text{Variance*} : x_{var} = \frac{1}{N} \sum_{i=0}^{N-1} (x[i] - \bar{x})^2$$

$$\text{Skewness} : x_{skew} = \frac{1}{N x_{\sigma}^3} \sum_{i=0}^{N-1} (x[i] - \bar{x})^3$$

$$\text{Kurtosis} : x_{kurt} = \frac{1}{N x_{\sigma}^4} \sum_{i=0}^{N-1} (x[i] - \bar{x})^4$$

$$\text{Resistance: } R_n = V_{\sigma} / I_{\sigma} ; A_n = I_{\sigma} / V_{\sigma}$$

$$\text{FFT: } X[k] = \sum_{i=0}^{N-1} x[i] e^{-j2\pi \frac{k}{N} i}$$

*Population-based definition

Fourier Transform

The Fourier Transform in the Analysis section provides the same analysis as in the Real-Time FFT. You may choose the

width of the region being analyzed, the resolution, and the appropriate smoothing window to eliminate edge effects.

Joint Time-Frequency Analysis (JTFA)

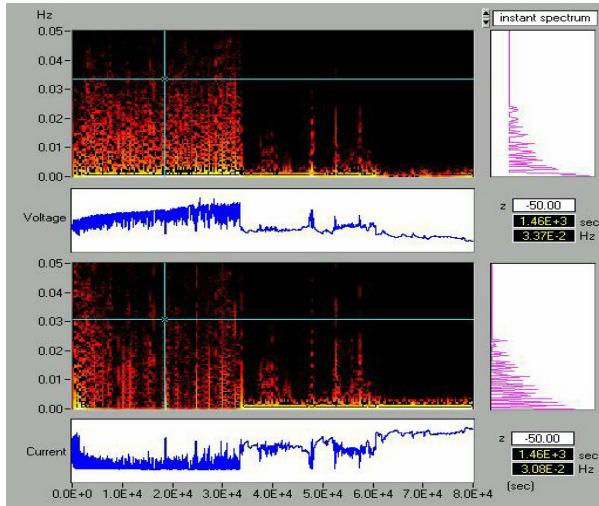

The Electrochemical Signal Analyzers introduces the Joint Time-Frequency Analysis, a powerful visual technique, for viewing and summarizing electrochemical noise data.

Traditionally, signals have been analyzed in either the time or the frequency domain. JTFA analyzes signals in both time and frequency domain *at the same time*. The amplitude of a signal is plotted as an intensity plot with the X-axis corresponding to time and the Y-axis corresponding to frequency.

In addition, the JTFA shows the original time series data and either instantaneous or overall spectra of the current and voltage signals for a powerful one chart summary of your signals.

JTFA on Active Pitting to Crevice Corrosion Transition

Power Spectral Density, Fourier Transform This method gives the energy of the voltage and current signals occurring at a given frequency. It also gives the ratio of the two power spectra. The power of the voltage signal is defined by: $P(f) = 2\hat{V}(f)^2$ where \hat{V} is the Fourier transform of the signal.

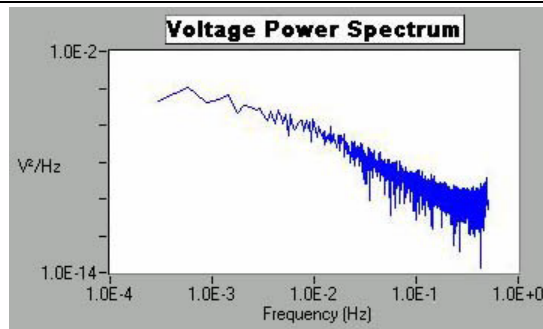

Power Spectral Density, Maximum Entropy Method

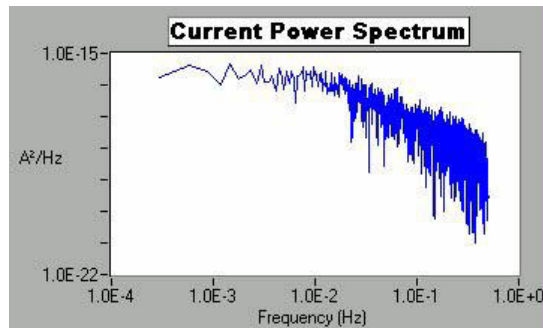
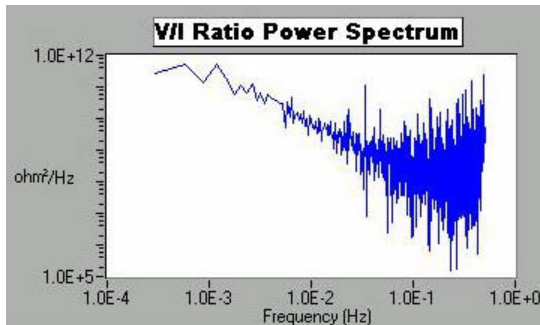

The Power Spectral Density (PSD) when calculated via a Fourier Transform tends to be noisy at high frequencies. The MEM algorithm smooths the PSD by fitting a time-domain signal of the form:

$$V_{smooth}[i] = \sum_{k=1}^M a_k V_{smooth}[i-k].$$

The order, M , of the MEM can be adjusted.

Cross Correlation Analysis

This analysis shows the correlation between the current and voltage signals. It is defined as the Fourier Transform of the cross correlation function:

$$R_{I,V}(m) = \sum_{k=0}^N V[k+m] * I[m]$$

where m measures the time interval, e.g., m sample periods between the two signals. When two signals are highly correlated, $R_{I,V}$ increases as m decreases.

Correlated V and I signals indicate that they are probably coupled through the electrochemical interface and, therefore, associated with electrochemical processes.

Impedance Spectrum

The impedance spectrum is by now well known to electrochemists and corrosion scientists. The software calculates an impedance by ratioing the frequency domain representation of the voltage signal to that of the current signal. Both MEM and FFT spectra are calculated.

Histogram Analysis

The histogram is a plot of the number of points at a given voltage or current for the entire data record. It is the

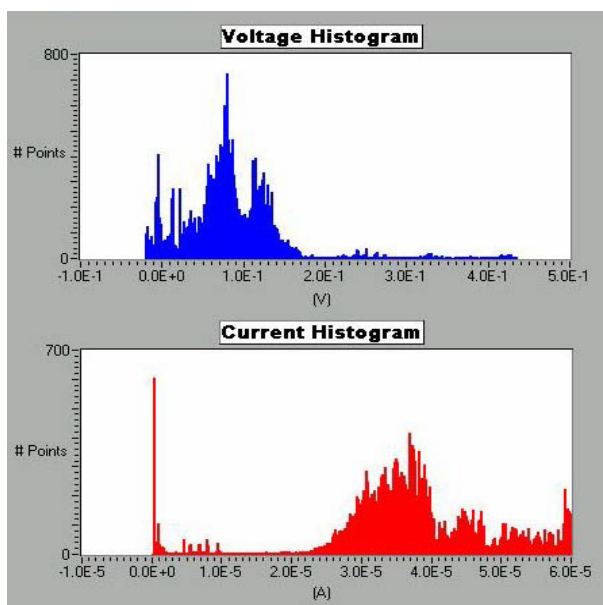

Data Import / Export

The Analysis features of the software can even be applied to data acquired with non-Gamry potentiostats. Data files in a tab delimited format can be conveniently imported into

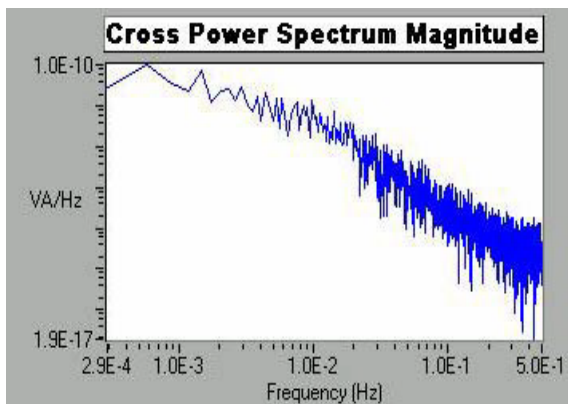

often, however, there is not enough noise present in laboratory environments to generate meaningful spectra. To obtain better accuracy in impedance spectrum, the software can apply a computer-generated white noise signal to the system under test.

distribution function on which the various statistical calculations are based.

Peak Finding and Counting

The Electrochemical Signal Analyzer can count the number of excursions above or below a limit. This analysis is often used to characterize localized corrosion processes. The minimum width of peaks or valleys can be specified.

Linear Detrending

Often it is handy to remove a background drift in voltage or current. This is done by fitting a straight line to the data set and subtracting it from each data point. Linear Detrending is typically performed prior to calculation of the RMS value of the data.

Data Normalization

Used to compare two non-identically scaled data sets, Data Normalization transforms each set to an equivalent set with a mean of 0 and standard deviation of 1. In this way, multiple data sets can all be plotted on the same "normalized" axes for ease of comparison.

the software and processed normally. Data can also be exported from the software in a tab delimited format to spreadsheets, databases, or other software packages.

Software Specifications

Acquisition Modes	Zero Resistance Ammeter, Biased Zero Resistance Ammeter, Potentiostatic, Galvanostatic
Acquisition Frequencies	0.1 to 1000 Hz at 13 discrete frequencies
Data Display	User selectable to display any or all of: Mean, RMS, Sigma, Variance, Skewness, Kurtosis, Instantaneous Resistance (E/I), and FFT
Data Block Size for Statistical and FFT Calculations	32 to 16,384 points
Data Analysis Modes	Joint Time-Frequency Analysis, Power Spectral Density, Real-Time FFT, Cross Correlation, Histogram Analysis, Real-Time Statistical Analysis, Peak Finding and Counting, Linear Detrending, Data Normalization, Impedance Spectra
Data Overlay	Up to six files with an option for normalization

Electronic Specifications

The electronic specifications for the Electrochemical Signal Analyzer depend on the system's

potentiostat. Consult Gamry Instrument's Potentiostat Brochure for detailed specifications.

Systems Information

The Electrochemical Signal Analyzer requires a Series G, PCI4, Reference family Potentiostat to acquire data.

Microsoft® Windows® XP, Windows Vista® or Windows® 7 or higher is required for operation of this software. Gamry recommends a computer with a 1 GHz processor or higher with 1 GB of RAM or higher.

Gamry Instruments can supply complete systems including the above items and system software installed in a desktop or notebook computer. Custom computer configurations, software, training, and installation are available by special order.

Version 1.0 5/21/2018

© Copyright 1990-2018 Gamry Instruments.

All specifications subject to change without notice.

